



# RECHARGEABLE LITHIUM-ION BATTERY CELL GENERAL SPECIFICATIONS

## CHANGDE YIKLIK ENERGY LIMITED

Tel: (86) 736-433 8338

Fax: (86) 736-433 8333

Battery Cell Model: INR14430A80 A

### 1. Specifications

1.1	Nominal Capacity	800 mAh
1.2	Minimum Capacity	760 mAh
1.3	Nominal Voltage	3.6 V
1.4	Internal Impedance	≤ 80 mΩ
1.5	Energy	≤ 2.88 Wh
1.6	Standard Charging	160 mA
1.7	Quick Charging	800 mA (1 C)
1.8	Charging Voltage	4.2 V
1.9	Continuous Discharging	2 A
1.10	Discharge Cut-off Voltage	2.75 V
1.11	Battery Cell Weight	≤ 18.5 g

### 2. Product Drawing

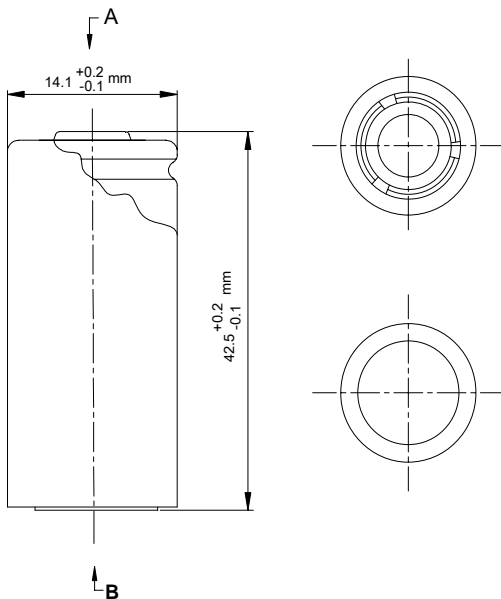

### 3. Characteristics: Charging

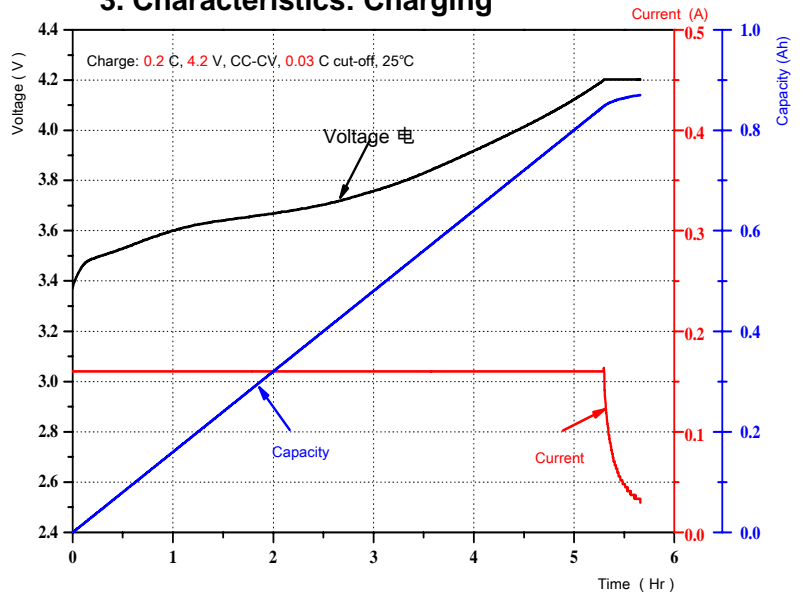

### 4. Characteristics: Different Discharge Rates

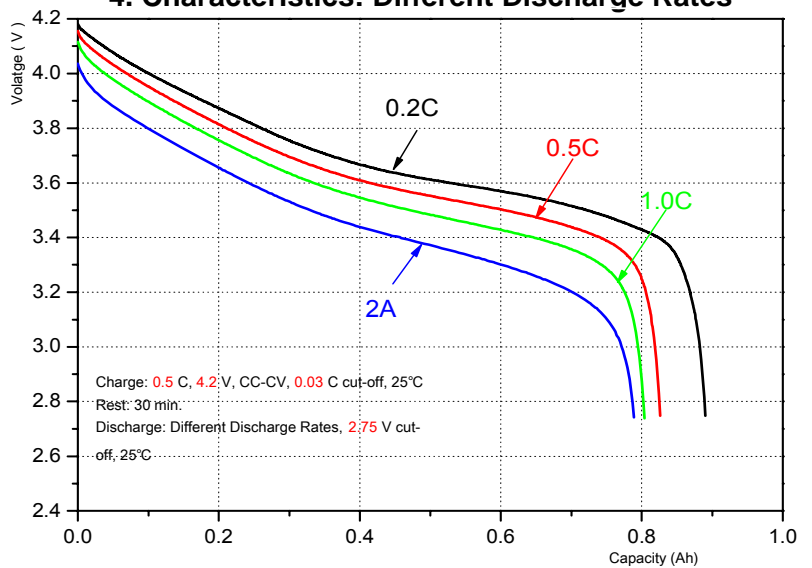

### 5. Characteristics: Cycle Life

