



RECHARGEABLE LITHIUM-ION BATTERY CELL GENERAL SPECIFICATIONS

CHANGDE YIKLIK ENERGY LIMITED

Tel: (86) 736-433 8338

Fax: (86) 736-433 8333

Battery Cell Model: NCR14430A92 A

1. Specifications

1.1	Nominal Capacity	920 mAh
1.2	Minimum Capacity	880 mAh
1.3	Nominal Voltage	3.6 V
1.4	Internal Impedance	≤ 80 mΩ
1.5	Energy	≤ 3.312 Wh
1.6	Standard Charging	184 mA
1.7	Quick Charging	644 mA (0.7 C)
1.8	Charging Voltage	4.2 V
1.9	Continuous Discharging	2 A
1.10	Discharge Cut-off Voltage	2.50 V
1.11	Battery Cell Weight	≤ 18.2 g

2. Product Drawing

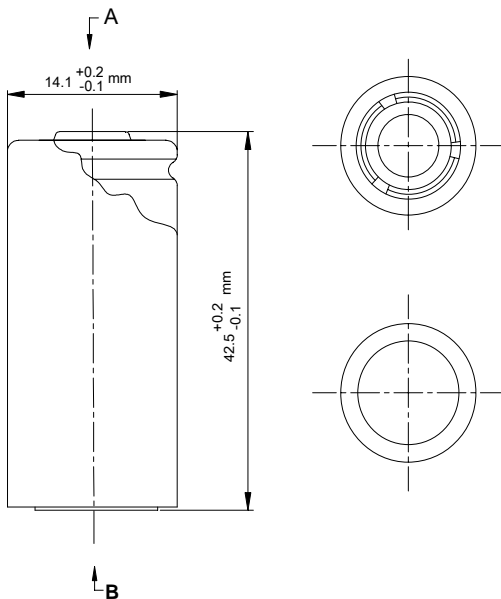

3. Characteristics: Charging

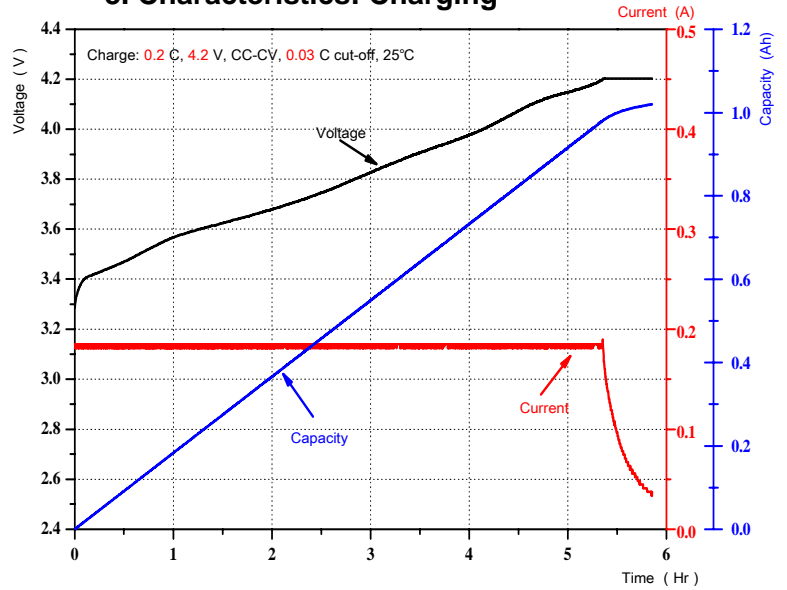

4. Characteristics: Different Discharge Rates

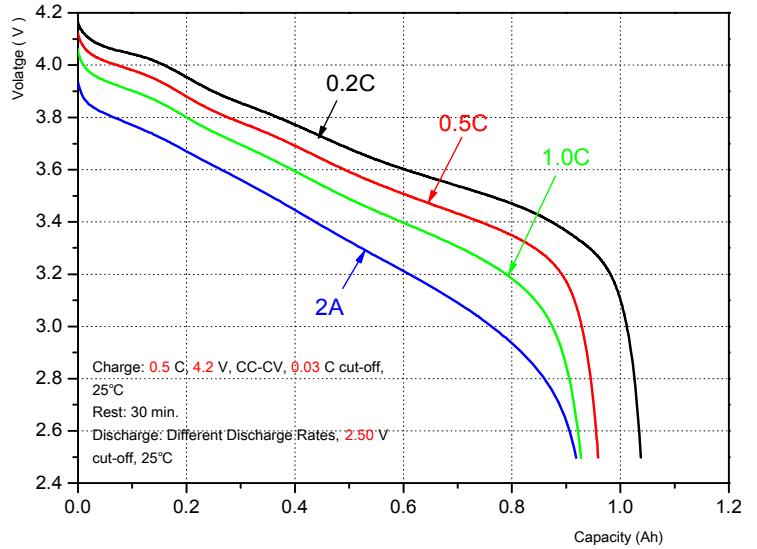

5. Characteristics: Cycle Life

